

A | B | C | D | E | F | G | H | I | J | K

1
2
3
4
5
6
7
8

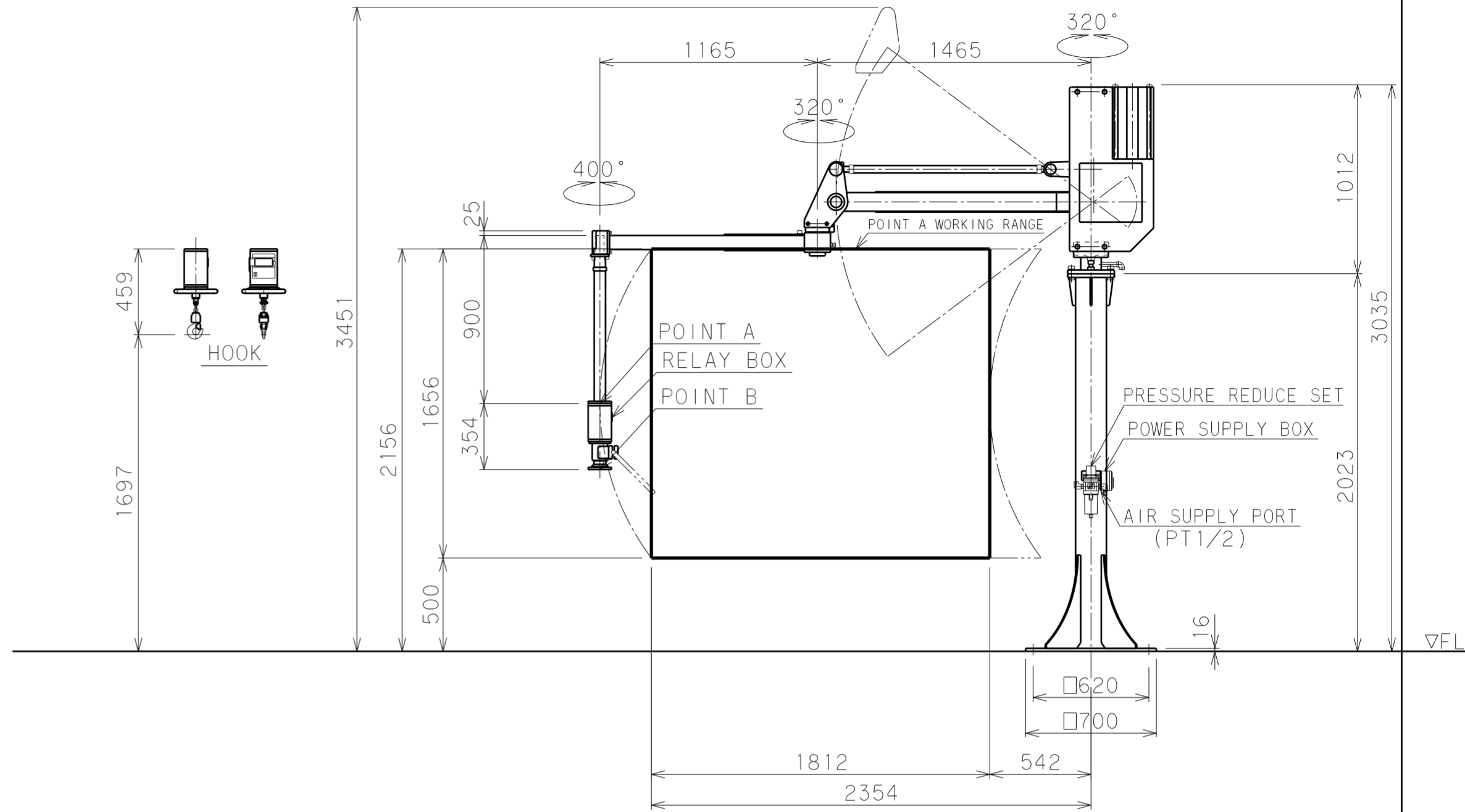
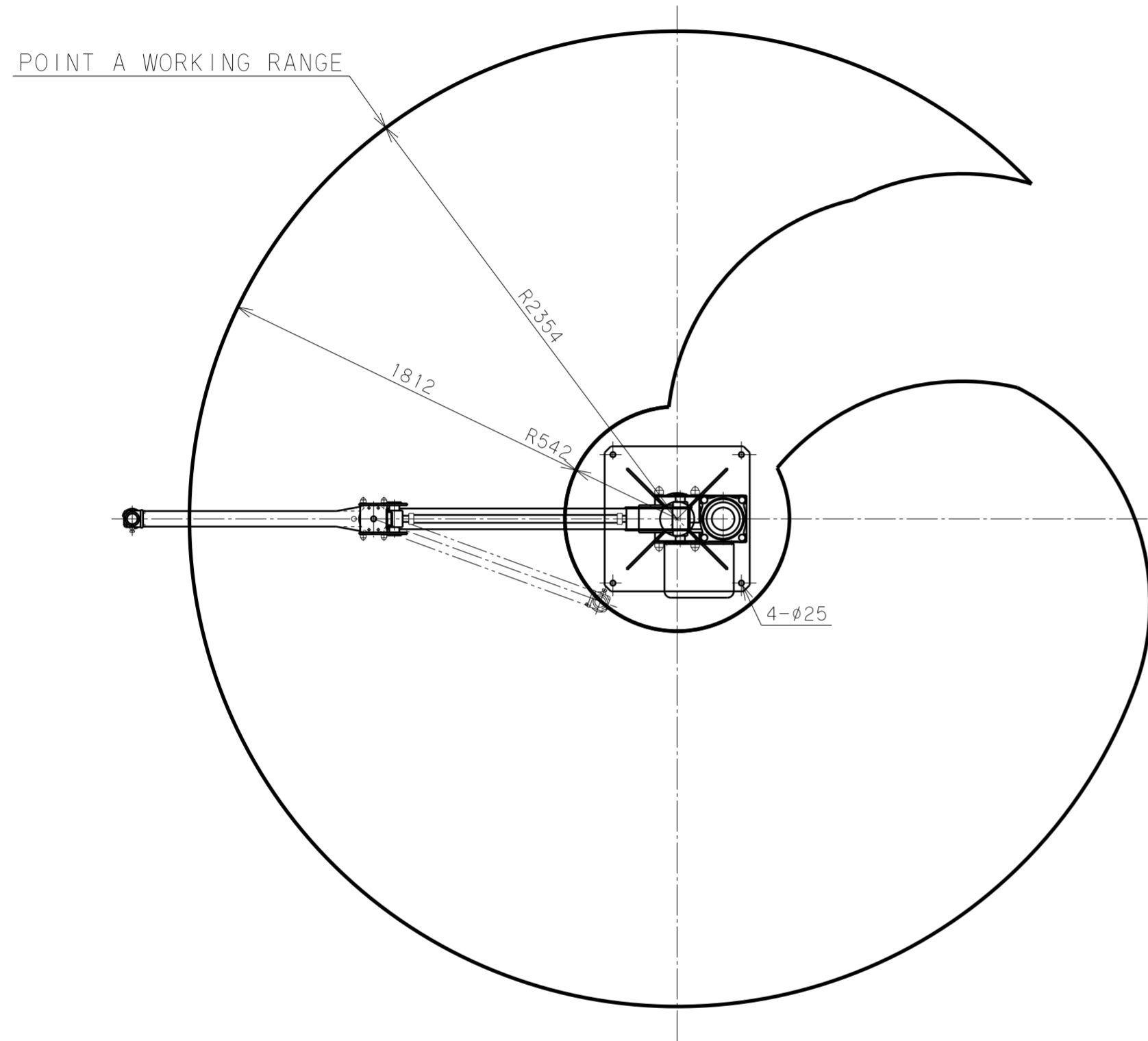

BALAMAN SPECIFICATIONS	
MODEL	U2BMS-150
MAX. LOAD	150kg (BELOW POINT A) 138kg (BELOW POINT B)
MAX. RADIUS	R2354 mm
HORIZONTAL STROKE	1812 mm
VERTICAL STROKE	1656 mm
MAX. WORKING HEIGHT	2156 mm
MAX. MACHINE HEIGHT	3451 mm
AIR SUPPLY	0.54 MPaG
AIR CONSUMPTION	192NL/min (15 SEC CYCLE)
POWER SUPPLY	SINGLE-PHASE AC85~AC264V 50/60Hz 0.1KVA
CONTROL METHOD	
COATING	MAIN BODY & BASE DIC233(DIC No.) 5Y8/1(MUNSELL No.) ATTCHMENT 10R5.5/14.5 (MUNSELL No.)
MAIN UNIT MASS	APPROX. 280kg
BASE UNIT MASS	APPROX. 130kg
RELAY BOX MASS	12kg
WORK PIECE MASS	kg
REMARKS	ACCESSORIES: PRESSURE REDUCE SET : POWER SUPPLY BOX