

A | B | C | D | E | F | G | H | I | J | K

1
2
3
4
5
6
7
8

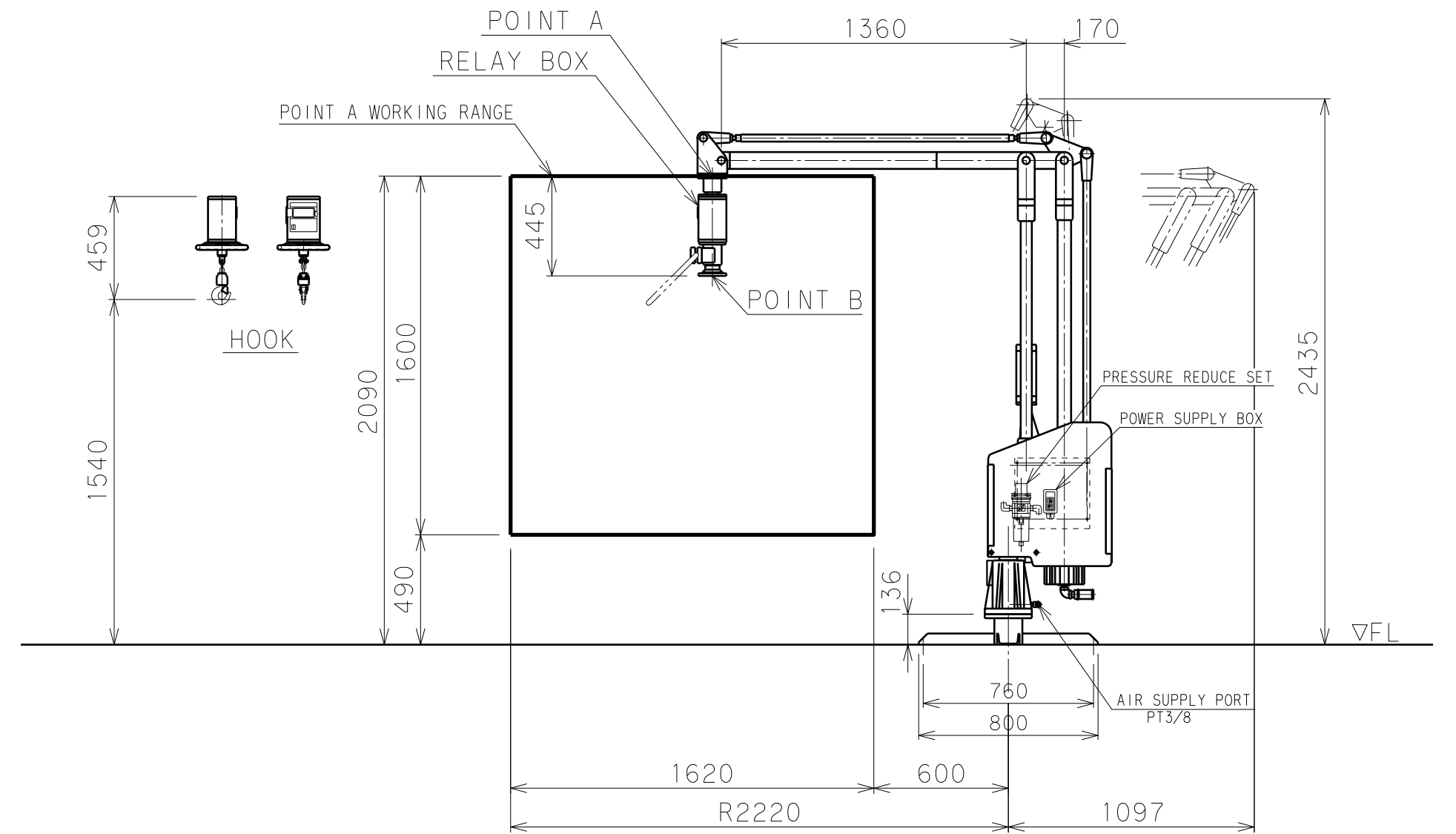
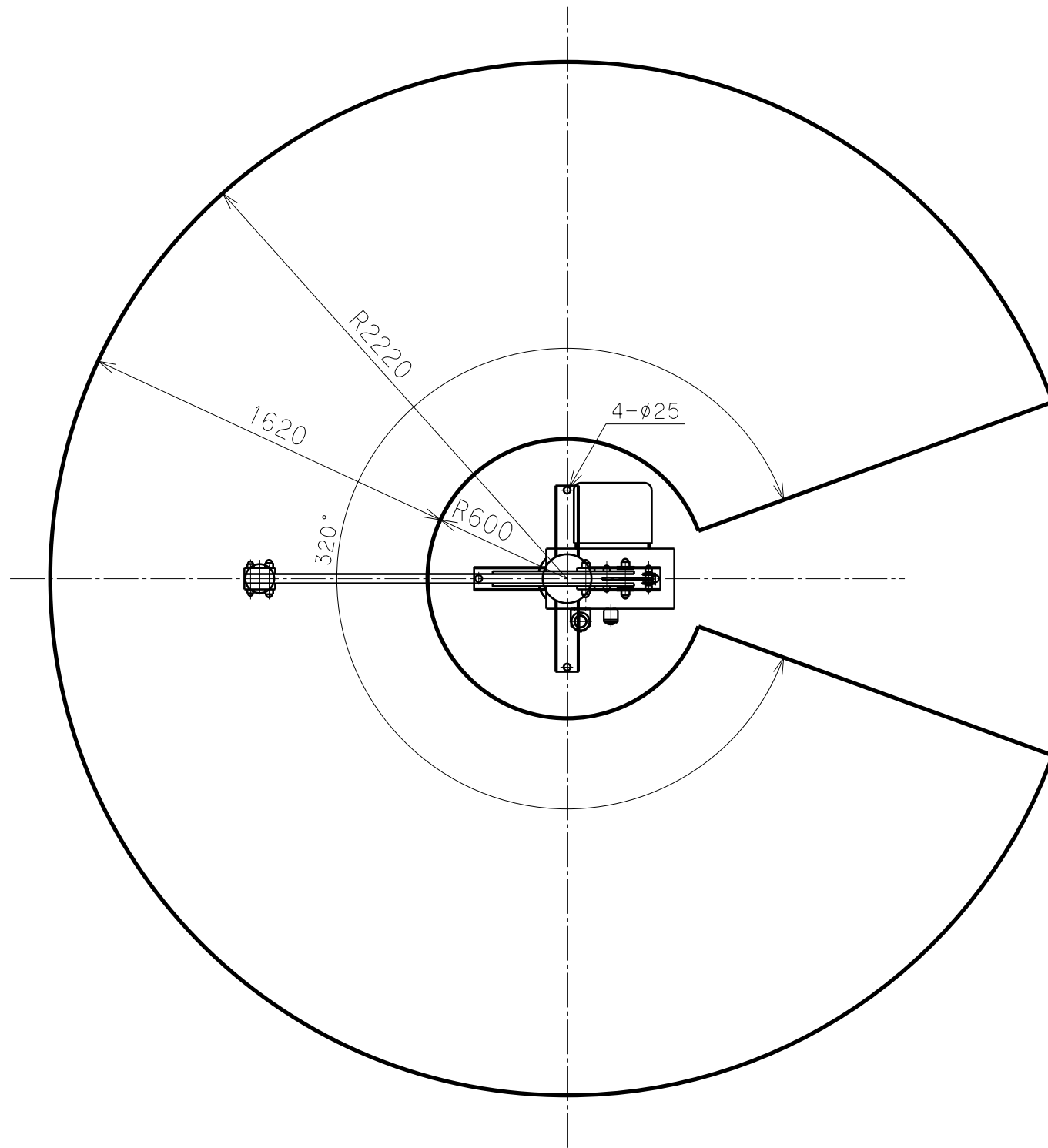

BALAMAN SPECIFICATIONS	
MODEL	U2BMG-75W
MAX. LOAD	75kg (BELOW POINT A) 59kg (BELOW POINT B)
MAX. RADIUS	R2220 mm
HORIZONTAL STROKE	1620 mm
VERTICAL STROKE	1600 mm
MAX. WORKING HEIGHT	2090 mm
MAX. MACHINE HEIGHT	2435 mm
AIR SUPPLY	0.54 MPaG
AIR CONSUMPTION	122NL/min (10 SEC CYCLE)
POWER SUPPLY	SINGLE-PHASE AC85~AC264V 50/60Hz 0.1KVA
CONTROL METHOD	
COATING	MAIN BODY & BASE DIC233(DIC No.) 5Y8/1(MUNSELL No.) ATTACHMENT 10R5.5/14.5 (MUNSELL No.)
MAIN UNIT MASS	APPROX. 220kg
BASE UNIT MASS	APPROX. 18kg
SWIVEL UNIT MASS	4kg
RELAY BOX MASS	12kg
WORK PIECE MASS	kg
REMARKS	ACCESSORIES: PRESSURE REDUCE SET : POWER SUPPLY BOX