

A | B | C | D | E | F | G | H | I | J | K

1
2
3
4
5
6
7
8

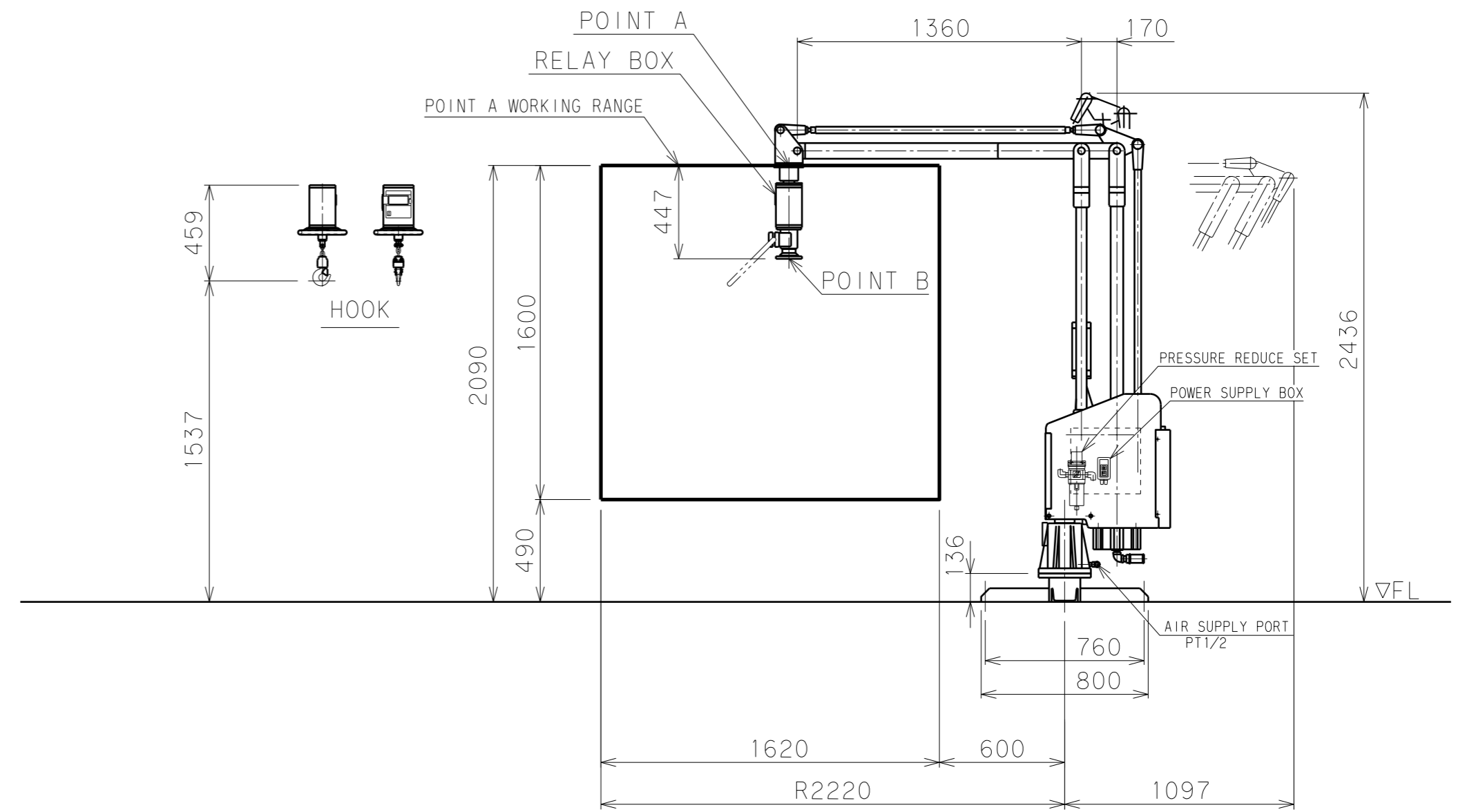
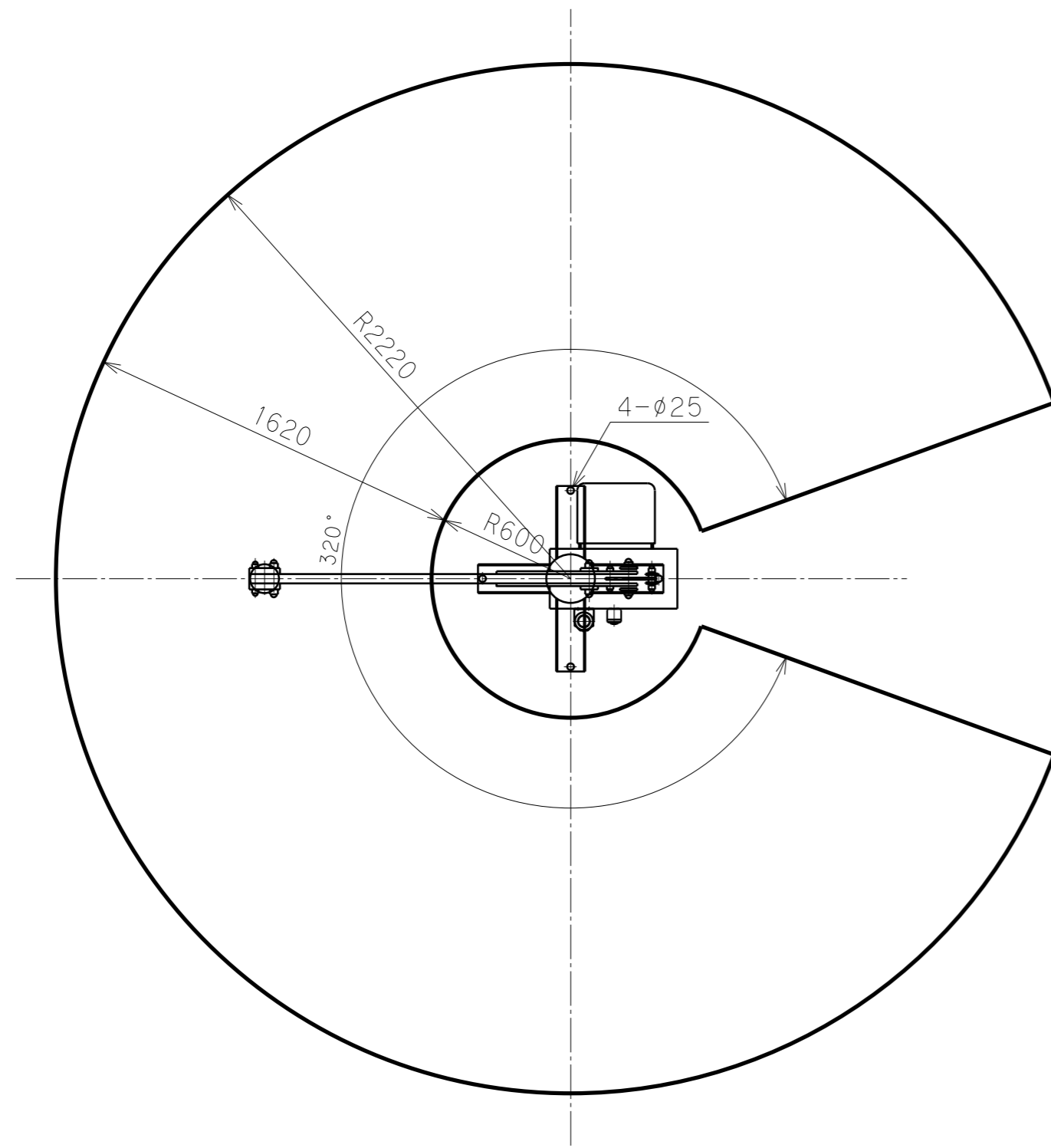

BALAMAN SPECIFICATIONS	
MODEL	U2BMG-150W
MAX. LOAD	150kg (BELOW POINT A) 133kg (BELOW POINT B)
MAX. RADIUS	R2220 mm
HORIZONTAL STROKE	1620 mm
VERTICAL STROKE	1600 mm
MAX. WORKING HEIGHT	2090 mm
MAX. MACHINE HEIGHT	2436 mm
AIR SUPPLY	0.54 MPaG
AIR CONSUMPTION	191L/min (10 SEC CYCLE)
POWER SUPPLY	SINGLE-PHASE AC85~AC264V 50/60Hz 0.1KVA
CONTROL METHOD	
COATING	MAIN BODY & BASE DIC233(DIC No.) 5Y8/1(MUNSELL No.) ATTACHMENT 10R5.5/14.5 (MUNSELL No.)
MAIN UNIT MASS	APPROX. 290kg
BASE UNIT MASS	APPROX. 25kg
SWIVEL UNIT MASS	5kg
RELAY BOX MASS	12kg
WORK PIECE MASS	kg
REMARKS	ACCESSORIES: PRESSURE REDUCE SET : POWER SUPPLY BOX